

Blood pressure monitor intended use:

Measures human beings Systolic, Diastolic blood pressure and heart rate using the oscillometric method. All values can be read out in one LCD DISPLAY. Measurement position is on adult wrist only.

Having one's blood pressure measured by a doctor in a hospital tends to stimulate nervousness in the person and may even create high blood pressure. Blood pressure in accordance with variety of conditions varies. So judgment is not possible on the basis of a single measurement.

It is better to take measurement at home. Regular home monitoring will let you have a record of your measurements. This information may provide a better reference of what your blood pressure really is, and may help your doctor make important decisions about your diagnosis and treatment.

If end-user has one of the diseases as heart troubles, kidney trouble, diabetes or frustration problem of blood vessel, please consult a doctor before using the devices.

What is blood pressure ?

Blood pressure is a measurement of the force of blood flowing against the walls of the arteries. Arterial blood pressure is constantly changing during the course of the cardiac cycle. **The highest pressure in the cycle is called the systolic blood pressure, the lowest is the diastolic blood pressure. Both pressure readings, the systolic and the diastolic are necessary to enable a physician to evaluate the status of a patient's blood pressure.** Many factors such as physical activity, anxiety or the time of day can influence your blood pressure. Blood pressure is typically low in the morning and increases from the afternoon to the evening. It is lower in the summer and higher in the winter.

Why is it useful to measure blood pressure at home ?

Having one's blood pressure measured by a doctor in a hospital or a clinic, and a group health checks, tend to stimulate nervousness in the subject and may even create high blood pressure. Also varies blood pressure in accordance with a variety of conditions and so **judgment is not possible on the basis of a single measurement.**

The blood pressure measured first thing in the morning after getting up, before taking any food and with the subject still, is known as the fundamental blood pressure. In practice it is rather difficult to record the fundamental blood pressure, but to come as near as possible to measuring the blood pressure in an environment that is close to this, is why it is useful to take the measurement at home.

WHO blood pressure classifications

Standards for assessment of high or low blood pressure without regard to age, have been established by the World Health Organization (WHO), as shown in Figure-1.

Variations in blood pressure

Individual blood pressures vary greatly both on a daily and a seasonal basis. These variations are even more pronounced in hypertension patients. Normally the blood pressure rises while at work and is at its lowest during sleeping period.

(Hypertension: means a person who has high blood pressure symptom.)

The graph (Figure-2) illustrated the variations in blood pressure over a whole day with measurement taken every five minutes.

(The thick line represents sleep. The rise in blood pressure at 4 PM (A in the graph) and 12 PM (B in the graph) correspond to an attack of pain.

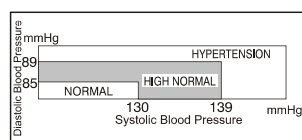

* Figure No.1

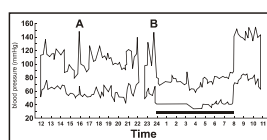

* Figure No.2

Important information before use of the unit

- Blood pressure measurements should be interpreted by a physician or trained health professional who is familiar with your medical history. By using the unit regularly and recording the results for your physician to interpret, you keep your physician informed of the continuing trends in your blood pressure.
- Wind the cuff snugly around your wrist and the cuff must be at the same level as your heart.
- Do not vibrate the unit during measurement, or the proper measurement will not be achieved.
- Perform measurement quietly in a relaxed position.
- Do not wind the cuff over jacket or sweater sleeve, or measurement cannot be done.
- Keep in mind, that blood pressure naturally varies from time to time through out the day and also is affected by lots of different factors such as smoking, alcohol consumption, medication and physical activity.
- People with a condition that causes circulatory problems (diabetes, kidney disease, arteriosclerosis or poor peripheral circulation) may get lower readings with this monitor that is used on the upper arm. Please consult your physician to determine if your wrist blood pressure accurately reflects your actual blood pressure.
- Blood pressure measurement determined with the unit are equivalent to those obtained by a trained observer using the cuff / stethoscope auscultation method. Within the limits prescribed by the American National Standard for Electronic or Automated Sphygmomanometers.

Device description

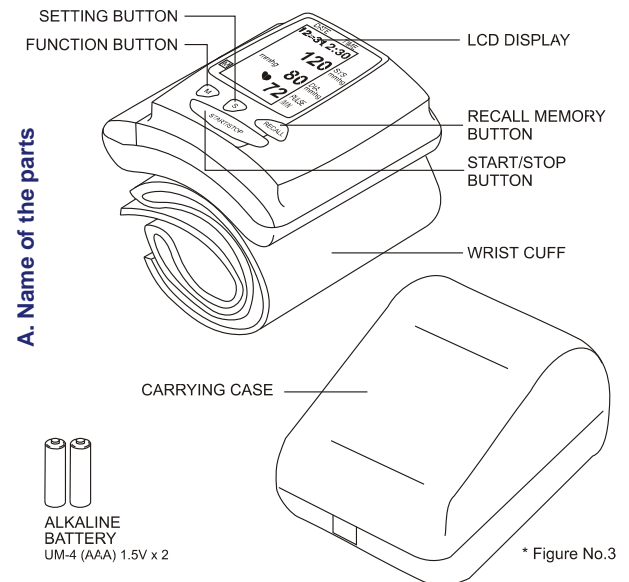

B. Description of display symbols

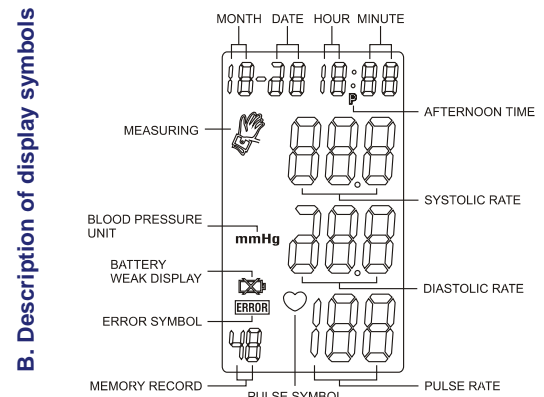

B. Description of display symbols

Changing batteries

Remove the battery cover at the lower side of the unit and insert batteries into the battery compartment as shown, taking extreme care that the polarities + and - are observed.

Important notice: You might encounter difficulties to take the batteries out. If so, use hard and tiny object such as a pen or others for help.

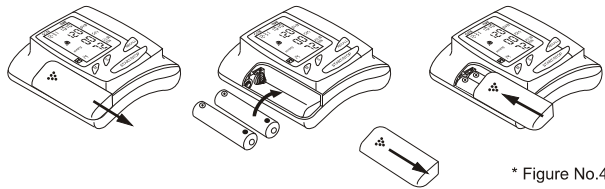

* Figure No.4

Attaching pressure cuff

1. Wrap the pressure cuff around the wrist.

- The display of the unit should be placed on the palm side of the wrist.
- The wrist should be bare.

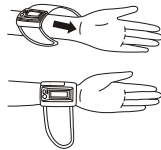

2. Fasten the pressure cuff snugly.

- Do not pull strongly on the pressure cuff.
- Do not make the pressure cuff too tight.

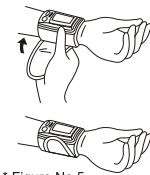

* Figure No.5

Correct measurement position

It is extremely important of the measured values, that the cuff is at the same height of the heart. Higher or deeper position will give deviations from the true value.

Measurement while sitting down:

- Place your elbow on a table or other object (such as our carry case)
- Use the armrest to position the arm so that the pressure cuff is at the same height as the heart.
- Relax your hand with the palm facing up.

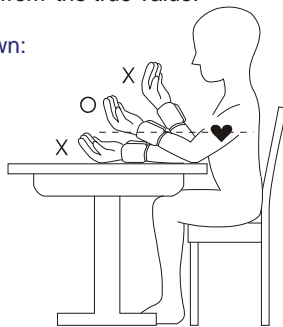

* Figure No.6

Description of display marks

Display mark	Condition/Cause	Corrective action
	Mark appears in the measurement condition and flashes when pulse is detected.	Measurements in progress remain quiet.
	Appears when the battery voltage is excessively low or the positions of batteries are incorrect.	Replace all two batteries by new ones. Insert the batteries at correct positions beware of the +/- directions.
	Appears when the accurate blood pressure could not be obtained accurately.	Press "start/stop" button again and re-measure. Or check cuff if wrapped at the wrist or according to instructions. Check palm if exerting effort. Check if talking or moving during measurement. Check if posture is incorrect.
	Appears all the time till the measurement being completed.	

How to measure

1. Inserting batteries in position:

- Open battery cover
- Refer to the picture in positioning batteries (Figure-4)
- All LCD segments will appear on the display in 3 seconds.
- Display 1 month 1 date, 12 hour 0 minute.

2. Setting Month, Date and Time:

- Press **(MODE)** button ("month" starts flashing)
Press **(SET)** button to set the correct month (1,2,3,...12)
- Press **(MODE)** button again ("date" starts flashing)
Press **(SET)** button to set the correct date
- Press **(MODE)** button again ("hour" starts flashing)
Press **(SET)** button to set the correct hour in 12-hour format.
- Press **(MODE)** button again ("minute" starts flashing)
Press **(SET)** button to set the correct minute (0,1,2,3,...59)
- Press **(MODE)** button again to switch to normal time.
(month, date, hour and minute appear on then display)

3. Steps to take blood pressure measurement:

- Wrap the cuff around the arm (Refer to Wrapping of Wrist cuff as Figure No.5)
- Sit upright on the chair to have correct posture. (Refer to Correct Posture in Taking Blood Pressure as Figure No.6)
- Press "SET/STOP" button all elements display '888' in 3 seconds. Afterward, display the update time. The measuring blood pressure symbol will flash on the display and then the air pressure will automatically pump up to 195mmHg. If blood pressure tends to be on the high level, the air pressure will automatically increase to the required level for measurement.
* Do not move or talk in the midst of taking blood pressure measurement.
- After the air pressure is increased, it will slowly decreased. When the pulse is detected, HEART RATE symbol will start flashing.
- After taking blood pressure measurement, the Systolic rate, Diastolic rate will be lasting flash on the display for 1 minute.

4. Storing, recalling and erasing measurement data:

a. Storing data:

After each blood pressure measurement, the Systolic rate, Diastolic rate, Pulse rate and the time & date of specific day will be automatically stored. The memory holds the latest 48 measurement data. If more than 48 measurements, the memory will automatically clear out the earliest data.

b. Recalling data:

- Pressing "RECALL" button at normal time, nothing will appear on the display if there is no data in the memory. If there is data in the memory, the latest recorded set of measurement which are the Systolic rate, Diastolic rate, Pulse rate, including the recording time and date, will appear and lasting on the display for 1 minute.
- Press "RECALL" button to read the next line of stored data. The data called up on the display is numbered accordingly. After reading the recalled data as rotatory 48-set of the stored data, press RECALL to switch to normal time.
- To discontinue in the midst of reading of the data, press "START/STOP" button to power off.

c. Erasing data:

- Take out the batteries and then re-ill 2 pcs batteries again.
- To check if the data is erased. Press "RECALL" button, no data should show up on the screen.

5. To change batteries:

When “” show up on the display, the battery is weak. Change the batteries or it will not be possible to take blood pressure measurement. All batteries used must be the same type. Do not mix alkaline, standard (carbon-zinc) or rechargeable (cadmium) batteries. Do not mix old and new batteries.

Maintenance

- Use a piece of cloth with water or mild cleansing agent to clean the case and then use a piece of dry cloth to wipe it dry.
- Do not use gas or any strong cleansers in cleaning.
- When the unit is not to be used for a long time, remove the batteries.
(Leaking of battery liquid can cause trouble.)

Safe-keeping

- Always keep the unit in the carrying case after its use.
- Do not put the item directly under the sunlight, in high temperature, or humid and dusty places.
- Do not store in extremely low (less than -20 C) or high (more than 60 C) temperature.

To Prevent Malfunction

- Do not in any way twist the arm cuff
- Do not start the air pressure when the wrist cuff is not wrapped around the wrist.
- Do not attempt to disassemble or change any parts of the monitor including wrist cuff
- Do not drop the product or put it through strong impact.

Warning

- The device measures the blood pressure of adult only.
- The device is not supposed to be used if your arm has any wound or injury.
- In case the cuff is pumping up and non stop, please open the cuff at once or just wait a few seconds till “ERROR” appears on the LCD. The device will shut off automatically.

Note

Measurement accuracy results were obtained by studies conduct at hospital in Taiwan.

The CE mark of device corresponds to EC directive 93/42/EEC. The blood pressure measuring device corresponds to European regulations EN1060 part 1 and EN1060 part 3.

The device complies with the EMC requirements according IEC 60601-1-2.

User group: the device is not suitable for invasive blood pressure measuring in adults or children. It is suitable for non-invasive blood pressure measuring for adults only.

Specifications:

Model number	: PH 168A
Method of Measurement	: Oscillometric
Range of Measurement	: Pressure 0-300mmHg, pulse 40-200 beats/minute
Accuracy Calibration	: Pressure +/-3mmHg, Pulse +/-5%
Fuzzy Pressure	: Automatic Re-inflation pump system
Inflation	: Automatic inflation (Air Pump)
Deflation of Pressure	: Automatic air release control valve
Exhaust	: Automatic exhaust valve
Display	: Liquid Crystal Digital Display
Sets of Memory	: 48-set
Unit Dimension	: L70 x W72 x H29mm
Unit Weight	: Approx. 140g including batteries
Cuff Size	: Wrist circumference approx. 135~195mm
Operating Temperature	: +10°C to + 40°C, 30-85% R.H.
Storage Temperature	: -20°C to + 50°C, 10-95% R.H.
Power Supply	: 2x 'AAA' (3.0V) Alkaline
Battery life	: Approx. 250 times with measurement
Accessories	: Carrying case, instruction manual, 2 pcs 'AAA' battery

These specifications are subject to change without notice for purpose of improvement.